Part III Technical Rules

Version 1 Feb, 2023. (All elder regulations are not valid). Only the version published on the www.eurotrial.eu website is valid.

These are technical rules and regulations for Eurotrial Championship for 2019 to 2023, and they are closed for this period of time.

In case of severe security risks, apparent errors in the regulation or unsportsmanship caused by a loophole of the rules, changes will be made by Eurotrial committee.

Changes in the regulation is done in red color and underlined, old text that is not valid is with blue text with line through.

3.1 Permissible vehicles - approval

3.1.1 Permitted vehicles

Only four-wheel-drive vehicles may participate in the competitions. For groups O, S and M, at least 50 identical vehicles must have been produced worldwide, and if there is any doubt about this or if the vehicle meet's the specifications, it is the owner's responsibility to proof this.

Quad and ATV are not permitted.

3.1.2 Classes

There are five groups you may participate in:

- Trial group O (original / original vehicles)
- Trial group S (standard / series vehicles)
- Trial group M (modified / improved series vehicles)
- Trial group PM (Pro modified / improved vehicles)
- Trial group P (prototypes)

3.1.3 Weight

The vehicle gross weight must not exceed 3500kg.

3.2 Safety regulations

3.2.1

To participate in Eurotrial, the vehicle must meet the Eurotrial safety regulations.

Changes of the vehicle are not allowed after technical inspection. Change to spare tire must be checked by technical inspection if it's another type or dimension.

3.2.2 Helmets

Passenger helmets must be worn in all groups and sections. The helmet must be designed for motorsport use.

3.2.3 Driving-suite

The driver and co-driver must wear a protective suit or an overall in all sections. Non fire-proofed overalls must be made from cotton.

3.2.4 Intercom

Intercom between driver and co-driver is allowed, all type of wireless systems is not allowed

3.2.5 Parking/emergency brake

The parking brake must be able to keep the vehicle stationary on a slope with 16 degrees inclination. The emergency must be able to stop a moving car in an effective way.

During the brake test, there will be a marshal sitting in the car to ensure that the vehicle is in 2WD, and that the driver don't use main brake system during the test of the emergency brake system.

Additional testing of the braking system can occur during the competition.

If a vehicle is picked out for a additional brake test when it is standing in line for the last section, and time runs out, the driver is allowed to drive the section after the testing, if the car is ok.

3.2.6 Safety cage/roll cage

3.2.6.1 Construction

Multi-tubular structure installed in the cockpit with the function to reduce the deformation of the passenger area in case of an impact or rollover.

Open Vehicles (all vehicles without original metal roof.

All open vehicles in all classes must have a fully welded rollcage that meets the minimum-requirements in each class.

Vehicles in class O and S with internal rollcage and original metal roof may use bolted connections.

The removable connections complying to drawing 1 or 2 must be used for joining the upper parts of the main rollbar, the front rollbar and the lateral half-rollbars. Maximum four removable connections are allowed in the basic structure 3.2.6.4

Rollcage with two lateral rollbars are not allowed. Connection type 1 must have at least 4 bolts with minimum size of M8 and at least ISO standard 8.8 or higher. Connection type 2 must have at least 2 bolts with minimum size of M8 and at least ISO standard 8.8 or higher.

Removable connections complying with drawings 3 or 4 are only valid for attaching roof reinforcement 3.2.6.7 and optional members, and are forbidden for joining the upper parts of the main rollbar, the front rollbar and the lateral half-rollbars. Connection type 3 or 4 must have a bolt with minimum size of M10 and at least ISO standard 8.8 or higher.

All removable connections must be fitted within the extension of the axis of the tubes, and may not be offset. They must not be welded once assembled.

B-bar, diagonal member and backstays must always be welded together.

Only allowed for original metal roof vehicles in class O and S.

Vehicles in class O and S with a combined internal and external rollcage may use bolted connection-plates at two positions on the roof at the B-bar, making the connection through the roof (as the rollcage itself does not pass through the roof) and therefore joining the two systems together. The connection-plates at the roof must sandwich the roof between the outer and inner rollcage and must be maximum 100cm² and have a minimum thickness of 3mm each. They must be welded to the outer and inner rollcage and then bolted together, through the roof, with at least 4 bolts each with minimum size of M8 and at least ISO standard 8.8 or higher. A maximum distance of 15mm between the tube outer circumference and the bolt head is allowed.

Only allowed for original metal roof vehicles in class O and S.

Vehicles in all classes with a external B-bar.

The external B-bar must be welded or bolted to a reinforcement plate, or a tube at the sill with minimum the same size as the B-bar. If the B-bar is connected to a tube at the sill, this tube must be welded or bolted to a welded reinforcement plate at the sill This reinforcement plate must be minimum 150cm² and 3 mm thick and it is recommended that it is L-shaped to distribute the forces evenly in the sill. There must also be a reinforcement tube between the reinforcement plate and the frame.

External A-bar/lateral halfbar must be fitted to the body with a reinforcement plate in the upper corners in the front of the windscreen, or to the reinforcement-plate/tube at the sill. If the A-bar is mounted in the sill the reinforcement plate must be minimum 150cm² and 3 mm thick and it is recommended that it is L-shaped to distribute the forces evenly in the sill.

The sill may not have any form of rust in the area where the reinforcement plate attached.

3.2.6.2 Specification of parts in the rollcage**Rollbar**

Tubular frame forming a hoop with two mounting feet.

B-bar, main bar

Structure, consisting of a nearly 90 degree tube, who is mounted crosswise in the vehicle. With an upright sitting position the helmet and shoulders must be in front of the B-bar outer dimension.

The B-bar must be bent and made from one piece of steel tube.

B-bar, diagonal member and backstays must always be welded together.

A-bar, front bar

Similarly as the B-bar, however it should follow the outer windscreen holders, as well as the upper edge of the windscreen. The A-bar must be bent and made from one piece of steel tube.

Lateral rollbar

Near-longitudinal and near-vertical single piece tubular hoop located along the right or left side of the vehicle, the front pillar of which follows the windscreen pillar and the rear pillar of which is near-vertical and located just behind the front seats. Each lateral rollbar must be bent and made from one piece of steel tube.

Lateral half-rollbar

Identical to the lateral rollbar but without the rear pillar. Each half-lateral rollbar must be bent and made from one piece of steel tube.

Longitudinal member

Near-longitudinal tube joining the upper parts of the A-bar and B-bar.

Transversal member

Near-transversal tube joining the upper parts of the lateral half-rollbars or of the lateral rollbars.

Diagonal member

Transversal tube between one of the top corners of the B-bar, or one of the ends of the transversal member in the case of a lateral rollbar, and the lower mounting point on the opposite side of the

rollbar, or the upper end of a backstay and the lower mounting point of the other backstay. B-bar, diagonal member and backstays must be welded together.

Backstay

Longitudinal tube between the top corners of the B-bar, or one of the ends of the transversal member, in the case of a lateral rollbar, and the rear of the vehicle. B-bar, diagonal member and backstays must be welded together.

Doorbar

Mandatory for all vehicles in class Pm and P.

A minimum of one longitudinal member must be fitted on each side of the vehicle. The lateral protection must be as high as possible, and if using a single bar, at least 10 cm from the bottom of the seat at the hip. The purpose of the doorbar is to protect the driver's and co-driver's hips in the event of rollover. For competitors without a co-driver, doorbars only need to be fitted on the driver's side. Single-seaters must have doorbars on each side. The doorbar must be welded to the rollcage and/or frame.

There must also be some kind of net and/or tube that prevent the lower parts of the leg from falling outside the vehicle in the event of a rollover. This net/tube can be part of a door and may be able to open.

Roof reinforcement

One, two or more tubes which runs diagonally across the roof, from one corner of the cage to the other corner of the cage, or two tubes in the shape of a cross or in the shape of a V. If the car have one tube which runs longitudinal from one of the highest points of the B-bar to the other side of the A-bar, this construction must also be reinforced in each corner. See 3.2.6.7

A space of at least five cm between the helmet and the tubes is recommended.

Padding

The distance between driver/codriver and any part of the rollcage is recommended to be at least 50mm. If the distance is less than 50mm, the tubes must be covered with shock absorbing protective padding. The thickness of the padding must be minimum 10mm.

Mounting foot

Plate welded to the end of a rollbar tube, to permit its bolting and/or welding to the bodyshell/chassis, usually onto a reinforcement plate. Jeep YJ/TJ original B-bar mounting feet need no reinforcement plate as the construction is known and strong enough in the original.

Reinforcement plate

3 mm steel plate fixed to the bodyshell/chassis under a rollbar mounting foot in order to more efficiently distribute the load onto the bodyshell/chassis. The minimum area of the plate must be 100cm². The steel plate must be fitted with screws or welded to the body. When the steel plate is screwed to the body, a same size, or bigger counterplate must be used. The plate must be attached with at least 4 screws of minimum size M8, at least ISO standard 8.8, or welded to the body. For vehicles with a plastic car body, the bars / rollcage must be attached to the frame. If the rollcage is welded to the frame, and the material thickness of the frame is 3 mm or more, no reinforcement plate is needed.

Roof

The roof space between the A and the B bars must be covered with a steel plate with a minimum thickness of 2 mm, or an aluminum plate with a minimum thickness of 3 mm.

The plate must be fitted with screws in at least six points (quantity M8, ISO standard 8.8) or welded with a minimum of six welding seams, each with a minimum length of 5 cm. If the roof is attached with screws, it's recommended to use mounting lugs welded to the rollcage. Mounting thru the tubes is not recommended. The minimum requirement is one seam/screw in each corner of the roof, one in the middle of the A-bar and one in the middle of the B-bar.

A space of at least five cm between helmet and plate is recommended.

Bending tubes

The tubing must be bent by a cold working process and the centerline bend radius must be at least 3 times the tube diameter. If the tubing is ovalised during bending, the ratio of minor to major diameter must be 0,9 or greater. The surface at the level of the bends must be smooth and even, without ripples or cracks.

If technical inspection consider that a bend isn't safe, they can demand that the driver has to weld a reinforcement like a gusset or a additional tube.

Welding

All required tubes, members and mounting foot of the basic structure 3.2.6.4, diagonal member 3.2.6.6 and roof reinforcement 3.2.6.7 must be welded together in all open vehicles regardless of class. In class M, Pm and P all parts of the rollcages must be welded.

All welds should be of the highest possible quality with full penetration of the tubes, and preferably using a gas-shielded arc. The weld must be implemented along the entire tube diameter.

Although good external appearance of a weld does not necessarily guarantee its quality, poor looking welds are never a sign of good workmanship.

Additional safety bars/tubes

Additional tubes/bars, for example doorbars, windscreen pillar reinforcement and similar, are allowed. No specifications regarding the construction or dimension of additional tubes/bars. All additional tubes are allowed to be attached with removable connections.

3.2.6.3 Tube dimension

For all constructions the minimum dimension is 38 x 2.5 mm (1,5"x0,095") or 40 x 2.0mm (1,6"x0,083"). Only constructions made from steel tube are allowed.

It's strongly recommended in case of replacing the B-bar/main-bar, a major repair of the cage or at new construction, to use cold drawn seamless unalloyed carbon steel tubes with a minimum tensile strength of 350 N/mm. Recommended tube size are 45x2,5mm (1,75"x0,095") or 50x2,0mm (2,0"x0,083") for the B-bar. Also recommended for A-bar/front-bar, lateral rollbar, half-lateral rollbar and transversal member.

3.2.6.4

No tubes included in the rollcage are allowed to be used as a container for any kind of liquid or gas.

3.2.6.5 Other constructions of rollcage

Other designs than those listed below can be approved if they are professionally built and where

their strength, and durability are well known.

Dispensation can be given for these structures after consulting technical manager.

3.2.6.4 Basic structure must be made according to one of the following designs

One B-bar
one A-bar
two longitudinal members
two backstays
six mounting feet

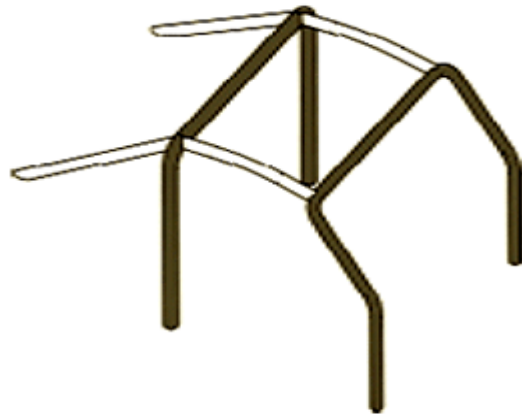

One B-bar
Two lateral half-rollbars
one transversal member
two backstays
six mounting feet

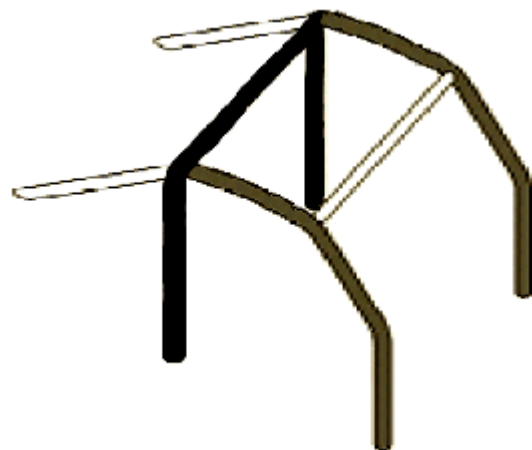

Two lateral rollbars
 two transversal members
 two backstays
 six mounting feet
 With this construction the diagonal member must be made double as a cross, right behind the seats.

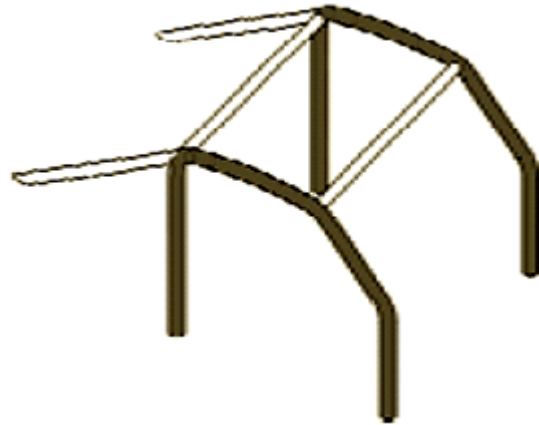

Two lateral rollbars
 two transversal members
 two B-bar stands
 six mounting feet
 With this construction the diagonal member must be made double as a cross, right behind the seats.



3.2.6.5 Doorbars:

At least one longitudinal tube must be fitted on each side of the vehicle.
 The tube(s) making up this protection must be welded into the rollcage in the rear.
 The design may be a single tube or a double like a cross.

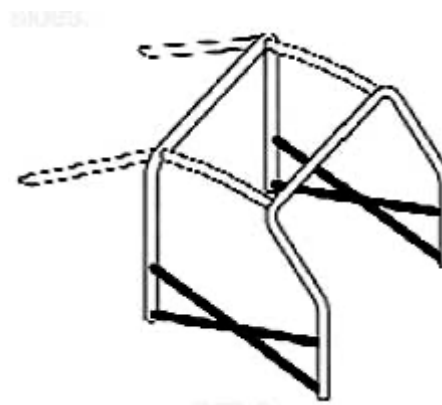
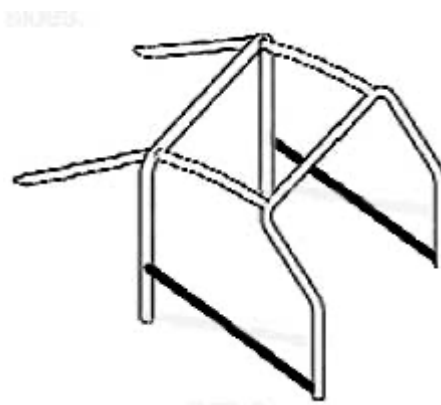

3.2.6.6 Diagonal member:

The cage must have one of the diagonal members shown on following drawing.

The orientation of the diagonal member be reversed, and made double as a cross.

Members must be straight.

Diagonal member may also be mounted in the B-bar.

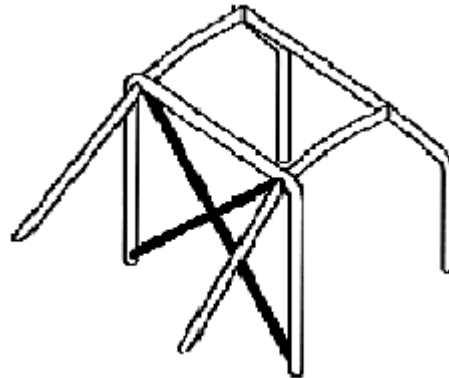
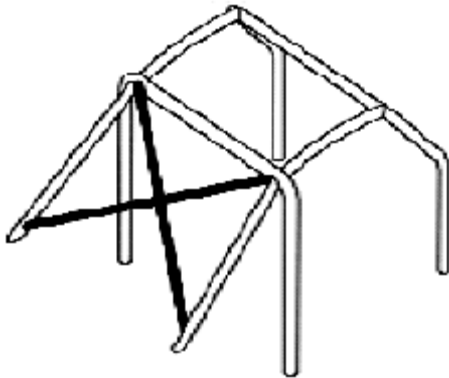
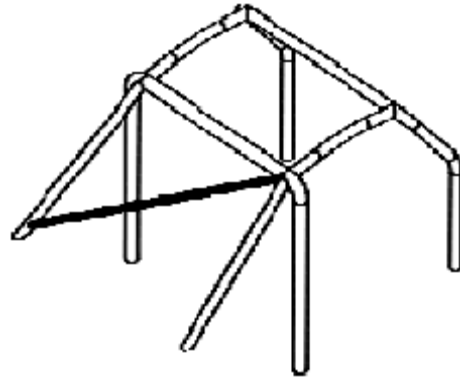

Diagonal member may also be designed as an inverted V, but then must also the roof reinforcement be shaped like a V.

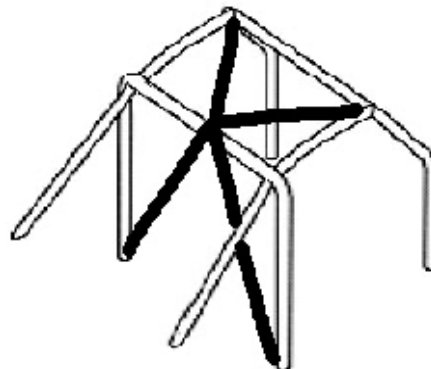
**3.2.6.7 Roof reinforcement:**

The upper part of the safety cage must comply with one of following roof reinforcement examples.

The reinforcements may follow the curve of the roof.

The orientation of the diagonal tube may be reversed, mirrored and made double as a cross.

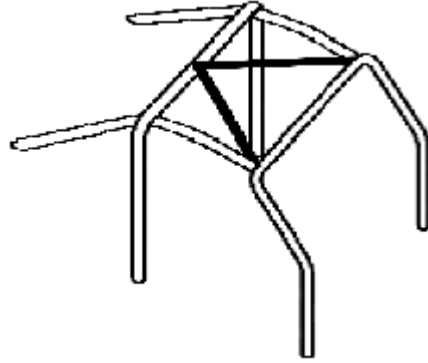
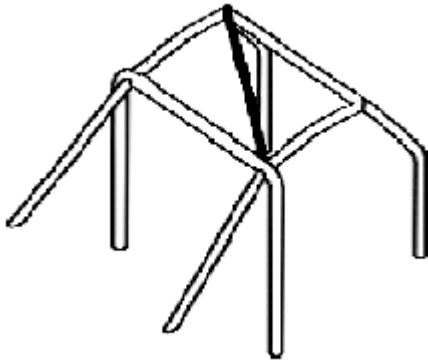

Tube which runs longitudinal from one of the highest points of the B-bar to the other side of the A-bar, must also be reinforced in each corner according to the drawing beside.
 A space of minimum five cm between helmet and tubes is recommended.

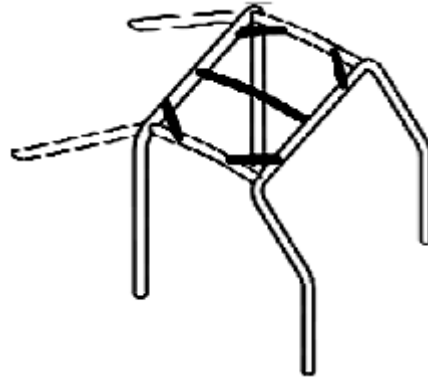

3.2.6.8 Removable connections:

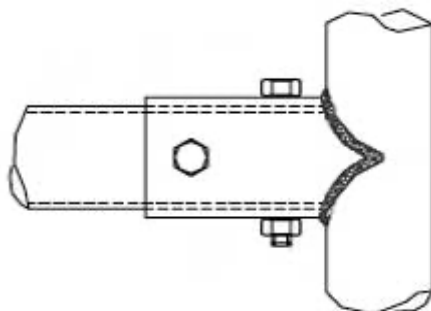
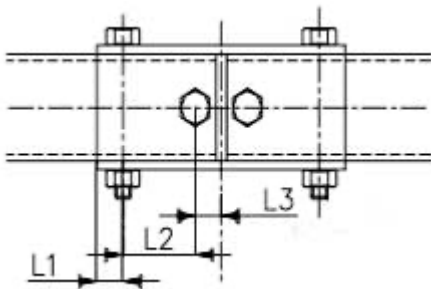

The removable connections type 1 (left) and 2 (left under & under) must be used for joining the upper parts of the main rollbar, the front rollbar and the lateral half-rollbars together.

Only allowed for original metal roof vehicles in class O and S.

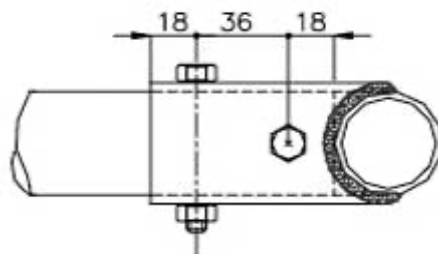

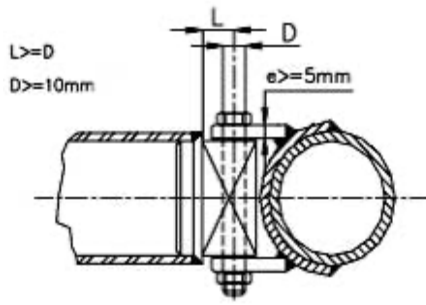

Only allowed for original metal roof vehicles in class O and S.

The removable connection type 3 (left) and type 4 (under) are only allowed for attaching roof reinforcement and optional members, and are forbidden for joining the upper parts of the main rollbar, the front rollbar and the lateral half-rollbars together.

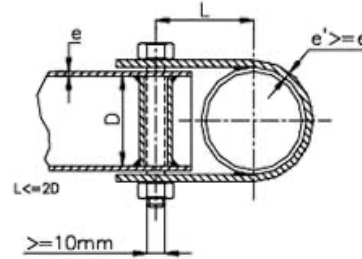

3.3 Environment

3.3.1 General information

Cars competing in Eurotrial should be built in a way that all forms of leakage (especially of oil and fuel) is reduced to a minimum.

3.3.2 Exhaust emissions

3.3.2.1 Diesel engines

Diesel engines must not be "tuned" so that they are at full throttle smoke too much.

Technicians at the inspection can make a visual assessment of a diesel engine exhaust emissions. This may only be made with the engine at normal operating temperature, and is done by depressing the accelerator pedal to a maximum, and then release it before the engine reaches its maximum speed. Even after the race started, a car can be taken out of the race if it is deemed too dirty in the exhaust.

3.3.3 Leakage

3.3.3.1

Small oil leakage, moisture, and occasional drops are acceptable.

In the event of large oil leaks occurring in the sketch during the competition, the official can stop the clock and point out to the driver that it is leaking. If the driver wants, he can complete the section.

3.4 TRIAL GROUP O (ORIGINAL VEHICLES)

3.4.1 General information

Modification of the vehicle is forbidden unless specifically allowed and only the permitted changes are allowed. The car must follow the manufacturer's conditions, like EU regulations or main importer regulations. All accessories and all special equipment, which can be supplied with the vehicle purchase, are allowed if no restrictions are present.

Only diesel or standard petrol is allowed as fuel. Beyond this the following regulations apply:

3.4.2 Frame/body

3.4.2.1 Frame/chassie/wheelbase

Original.

3.4.2.2 Body

Original. Sill protection is allowed other body protection is not allowed, body parts can only be replaced by original body parts or similar in the same material. All body parts must be firmly attached in their original fastening spots with original or similar fastening hardware.

3.4.2.3 Dimension / Vehicle outline

The dimensions must correspond to the manufacturer data.

The vehicle outline may not be changed with masking tape or other measures.

3.4.2.4 Window/window frame/mirror

Windscreen frame may not be removed or folded down. If a windscreen is used it must consist of laminated glass, Lexan/Polycarbonate or Makrolon. Plexiglas is forbidden. Windscreens should not have damages, for safety reasons. Should damage occur the windscreen must be approved by technical control. Mirrors of all kinds are allowed.

3.4.2.5 Body lift

Not allowed.

3.4.2.6 Bumper

The bumpers may not be removed. The plastic bumper corners may be removed if they are removable in original. In the case of partly or totally damaged bumpers during the section, they must be repaired before the next section. No additional bumper protection is allowed

3.4.2.7 Floor / firewall / transmissio tunnel

Original.

3.4.2.8 Passenger area

Original.

Floor mat and headliner may be removed, otherwise no changes allowed.

3.4.2.9 Seats

The seats for the driver/codriver must be well secured. Seats must have head restraints that covers at least 2/3 height of the helmet. Codrivers seat must be present. Its allowed to replace the original seats with racing seats with the possibility for 4 point harness.

3.4.2.10 Harness

Harness must at least be of type 4-point belts or so-called suspender belts (y-belts) or more, and they must be well attached to the body and/or rollcage according to harness manufacturer's specifications. The harness must be in good condition and may not be modified. If new mounting points are created in the body, a steel reinforcement plate with a surface area of at least 40 cm² and a thickness of at least 3 mm must be used. The passengers must be buckled at all time in the section during driving or rescue. The belt system used is to be put on according to its regulation and may not be manipulated. Vehicles with active airbag or belt restrain systems must be marked at both doors with the "Airbag"-symbol. It's allowed to remove the airbags, and in case of removal of passenger airbag, the hole in the dash-panel from the airbag must be covered.

3.4.2.11 Rollcage

A sixpoint rollcage is mandatory. The rollcage must consist of a Basic structure according to 3.2.6.4, backstays, diagonal member 3.2.6.6 and roof reinforcement 3.2.6.7.

Outside rollcage is allowed but, but additional tubes can not in any way protect the body parts except sills. See 3.2.6 for more info.

3.4.2.12 Protective netting /Armstraps

Protection nets or armstraps must be used. Net must cover the door/window area so the arm/hand cannot come outside the car. This also applies to armstraps. If arm straps are used they must open together with the harness.

3.4.2.13 Body attachment

Hardtop, tarpaulin with linkages inclusive all locked mounting plates, tailgate, rear seats, spare wheel, spare wheel handle, mirror and mirror handle, door and back windows may be removed. Edgeways mouldings, side turn signal, door handles and the **original doors** must be present. Original doors can be reduced to half doors. Interior door panel must be present. Material free, however not paper, cardboard, fabric or similar.

Vehicles delivered without doors must likewise be equipped with at least half doors. It's the drivers responsibility to prove that the vehicle is delivered without doors, otherwise the original doors must be used. The material must be splinter-proof, for example wood, metal, Lexan, and the material must not be transparent.

Definition for half doors with vehicles without serial doors:

There must be a cover available, which prevents feet or legs from falling out when the vehicle is tilted. This cover must have at least the height of the belt line of the vehicle. In addition the cover must have at least the height of the highest point of the unloaded seat. The cover can be made to be opened. The door must be able to open from the outside, or have a marking on the outside that shows where the opening is on the inside of the door. Belt line is defined as follows: In front the line of the bonnet. For open vehicles back and side, the side above the wall. For closed vehicles, if no open version exists, the bottom edge of the side window, and the back window.

3.4.2.14 Fluid tubes

Original.

3.4.2.15 Towing eye/hook

There must be either one towing eye or hook in the front and in the back with an inside diameter of at least 50 mm. They must be firmly embodied, easily accessible and have to be painted red, yellow or orange, so that the body of the vehicle contrast with the towing eye/hook.

3.4.2.16 Undershield

Undershield is optional.

3.4.3 Suspension**3.4.3.1 Spring**

The type of springs must correspond to its original technical specification.

3.4.3.2 Spring pendants

Original. Revolver shackles is not allowed.

3.4.3.3 Shock absorber

Shock absorbers are free of choice, however the number of shock absorbers, the working principle, and the fastening points must remain identical to its original design. Gas-pressure shock absorbers are to be regarded from the work principle as hydraulic shock absorbers.

Adjustable shock absorbers are forbidden.

3.4.3.4 Bump stop

Original.

3.4.3.5 Level control

A serial level control may be inserted while maintaining the original work version.

3.4.3.6 Torsion stick / Stabilizer bar

Stabilizer must be present in original form and function.

3.4.4 Steering**3.4.4.1 Steering**

The steering stop screws are optional.

3.4.5 Brake**3.4.5.1 Brake**

Vehicles with drum brakes may be reequipped at the front axle with disc brakes.

The serial track width must be kept.

Brake tubes and brake hoses must be in original, and well secured in original way. Plastic stripes are not allowed.

3.4.5.2 Parking brake/emergency brake

The parking brake must be maintained in the original, and in good condition. It's allowed to relocate / modify the parking brake handle if it's not reachable with 4/6 point harness.

It is allowed to move a foot operated parking brake pedal sideways to allow mounting of a 6-point rollcage. The parking/emergency brake must be able to slow down the vehicle in case of failure of the regular brakes. See 3.2.5 for test procedure.

3.4.5.3 Steering brake

Not allowed.

3.4.6 Wheels**3.4.6.1 Tire**

The maximum size of tires is 825 x 275 mm.

Max depth of the tire pattern is 16 mm, measure point is in the middle of the profile. The maximum of allowed tire types are Mud-terrain-profiles (MT-Profile). Not allowed are competitions tires like "Alligator", "Bronco Dirt Devil", "Greenway Diamond Back", spikes and chains. The mounting of dual tires is not permitted. If there are doubts about the profile, the Eurotrial-committee must decide. (so far refused tires see ANNEX 3.2 and 3.3).

3.4.6.2 Rim

Only serial motor vehicle type – bounded rim sizes may be used. (Diameter, width, and insertion-depth). Cars that normally are distributed with tires smaller than 205 R 16 or 6.50 / 16 are allowed to use these sizes with rims ET 20-25.

Spare wheels and/or tires can be removed.

3.4.6.3 Wings

Original.

3.4.7 Engine

3.4.7.1 Engine

Engine must correspond to it's original technical specification.

3.4.7.2 Mixture preparation

If there is a defect with the gas control it must be ensured that the engine goes on idling (e.g.: by a spring at throttle valve shaft).

3.4.7.3 Cooling

Original.

3.4.7.4 Fueltank / fuelpipe

The original tank must be kept in its outer form and in its function in original place. Protection plates are allowed.

7.4.7.5 Exhaust

After the last serial muffler the exhaust system is free of choice. The rear of the exhaust system must be designed so that it's possible to make a control of vehicle noise without problem. Noise limitation: The volume of the exhaust system may reach max. 98+2 decibel (DMSB near field measuring method)

3.4.8 Drivetrain

3.4.8.1 Gearbox

Gearboxes and gearbox ratio must correspond to original specifications.

Vehicles with automatic gearboxes must be secured so that the engine only can be started in "Neutral" and/or "Park".

3.4.8.2 Axle/axle ratio

Axles and axle ratio must correspond to original specifications.

All kinds of portal-axles are forbidden. Even if it's original equipment.

3.4.8.3 Diff-lock

The use of the differential lock and how one handles it for the rear drive axle is free of choice. Further differential locks are permitted, if these are serial specific locks. The component that makes this work must also be serial specific. The same applies to electronic driving assistance.

3.4.8.4 Disconnect of axle / drive system

The disengagement of drive axles is not permitted, unless it corresponds to the series. Remanufacturing to 2WD Low is not permitted.

3.4.9 Electric

3.4.9.1 Battery

The battery must be securely fastened in its original place.

The positive battery terminal has to be covered to prevent contact to other metal parts.

3.4.9.2 Main circuit breaker

A main circuit breaker is mandatory. The main circuit breaker must cut all electrical circuits, battery, alternator or dynamo, lights, ignition, electrical controls, etc. and must also stop the engine.

It is allowed to not break "memory" power supply to the engine control unit, gearbox control unit and similar electronic units in the car. The memory power supply line must be protected by a fuse mounted near the positive pole of the battery.

The main circuit breaker must be installed on the driver's side in front of the windshield. It must be reachable from the inside and from the outside. It must have a noticeably marked on/off position. Diesel engines which do not have an electrical "turn off"-solenoid must have a "stop the engine"-wire installed along with the main circuit breaker.

3.4.9.3 Lights

It's mandatory to keep the appearance of original headlights and taillights and they must correspond to their original form, meaning that they can be replaced with painted copies made from plastic with identical dimensions as original. It is allowed to replace bumper-mounted front and rear lights with copies made of plastic or painted metal.

3.4.9.4 Electronic support

It is not allowed to use electronic like radios cameras and sensors

3.5 TRIAL GROUP S (STANDARD VEHICLES)

3.5.1 General information

Modification of the vehicle is forbidden unless specifically allowed and only permitted changes are allowed. The car must follow the manufacturer's conditions, like EU regulations or main importer regulations. All accessories and all special equipment, which can be supplied with the vehicle purchase, are allowed if no restrictions are present.

Only diesel or standard petrol is allowed as fuel. Beyond this the following regulations apply:

3.5.2 Frame/body

3.5.2.1 Frame/chassie/wheelbase

Original. Fittings for engine, gearbox, transfer box and brackets for exhaust systems may be moved or modified, otherwise no changes are allowed. Bumper-mounting-plates can be removed or cut.

3.5.2.2 Body

Original. Parts that are attached/fitted by screws to the body (e.g. bonnet, wings etc.) may be replaced by parts made of plastic or fiberglass, provided they have identical external dimensions. Body protection is allowed.

3.5.2.3 Dimension / Vehicle outline

The dimensions must correspond to the manufacturer data.

The vehicle outline may not be changed with masking tape or other measures.

3.5.2.4 Window/window frame/mirror

Windscreen frames may not be removed or folded down. If a windscreen is used it must consist of laminated glass, Lexan/Polycarbonate or Makralon. Plexiglas is forbidden.

Windscreens should not have damages, for safety reasons. Should damage occur the windscreen must be approved by technical control.

Mirrors of all kinds are allowed.

3.5.2.5 Body lift

Bodylift is permitted with a maximum height of 50mm. This must be rigid.

3.5.2.6 Bumper

Bumpers and bumper mounting plates may be removed. It may be exchanged by other nonserial bumpers, however the form is not allowed to be molded or shaped to the vehicle. The material must be rigid and firm. Material thickness is free of will: Cover plates (or similar material) between body and frame are forbidden.

3.5.2.7 Floor / firewall / transmissiontunnel

Original.

Its allowed to make new hole for gearlever in transmissiontunnel when changing gearbox, otherwise no change.

3.5.2.8 Passenger area

Original.

3.5.2.9 Seats

The seats for the driver/codriver must be well secured. Seats must have head restraints that covers at least 2/3 height of the helmet. Codrivers seat must be present. Its allowed to replace the original seats with racing seats with the possibility for 4 point harness.

3.5.2.10 Harness

Harness must at least be of type 4-point belts or so-called suspender belts (y-belts) or more, and they must be well attached to the body and/or rollcage according to harness manufacturer's specifications. The harness must be in good condition and may not be modified. If new mounting points are created in the body, a steel reinforcement plate with a surface area of at least 40 cm² and a thickness of at least 3 mm must be used. The passengers must be buckled at all time in the section during driving or rescue. The belt system used is to be put on according to its regulation and may not be manipulated. Vehicles with active airbag or belt restrain systems must be marked at both doors with the "Airbag"-symbol. It's allowed to remove the airbags.

3.5.2.11 Rollcage

A sixpoint rollcage is mandatory. The rollcage must consist of a Basic structure according to 3.2.6.4, backstays, diagonal member 3.2.6.6 and roof reinforcement 3.2.6.7.

External rollcage is allowed.

See 3.2.6 for more info.

3.5.2.12 Protective netting /Armstraps

Protection nets or armstraps must be used. Net must cover the door/window area so the arm/hand cannot come outside the car. This also applies to armstraps. If arm straps are used they must open together with the harness.

3.5.2.13 Body attachment

Hardtop, tarpaulin with linkages inclusive all locked mounting plates, tailgate, rear seats, spare wheel, spare wheel handle, mirror and mirror handle, side and back windows, side turn signals, door handles and door upper sections may be removed (door lower part must be present). Interior door panel must be present. Material free, however not paper, cardboard, fabric or similar.

Original doors can be changed to half-doors. The door must be able to open from the outside, or have a marking on the outside that shows where the opening is on the inside of the door. Definition for half doors: There must be a cover available, which prevents feet or legs from falling out when the vehicle is tilted. This cover must have at least the height of the belt line of the vehicle. In addition the cover must have at least the height of the highest point of the unloaded seat. The cover can consist of e.g. sheet metal, wood, lattice, etc. and the material must not be transparent. The cover/half door can be made to be opened.

3.5.2.14 Fluid tubes

A protection of the fluid tubes for the fuel -, oil-, and brake hoses outside of the body must be provided against damages (stones, corrosion, mechanical breaks etc..)

Inside the body the tubes must be protected from any fire risk and/or potential damage by rigid metal shield. Fuel/coolant-tube/pipe/hose going through the drivers cabin must be "seamless" (no connections/joints inside drivers cabin) to prevent fluid from spreading into

the passenger area.

If the series arrangement is maintained, no additional protection is necessary. [ther](#).

3.5.2.15 Towing eye/hook

There must be either one towing eye or hook in the front and in the back with an inside diameter of at least 50 mm. They must be firmly embodied, easily accessible and have to be painted red, yellow or orange, so that the body of the vehicle contrast with the towing eye/hook.

3.5.2.16 Undershield

Undershield is optional.

3.5.3 Suspension

3.5.3.1 Spring

The type of spring must be of original design (coil spring, leaf spring, torsion or pneumatic). Lifting springs are allowed. The fastening points of the springs must be kept in the frame and axle. Shackle reverse is not allowed. It is not allowed to move the fastening points of support, control and/or radius arm in the frame or axle, in a coilsprung car. Change of radius arm are allowed, likewise material of radius arm and bushing. Johnny-joints, universal-joints or any kind of free moving joint is not allowed.

The original wheelbase and the original position of the axles must be kept.

3.5.3.2 Spring pendants

Longer spring pendants are permitted. Revolver shackles are not allowed.

3.5.3.3 Shock absorber

Shock absorbers are free of choice, however the number of shock absorbers, the working principle, and the fastening points must remain identical to its original design. Gas-pressure shock absorbers are to be regarded from the work principle as hydraulic shock absorbers.

Adjustable shock absorbers are forbidden.

3.5.3.4 Bump stop

Optional.

3.5.3.5 Level control

A serial level control may be inserted while maintaining the original work version.

3.5.3.6 Torsion stick / Stabilizer bar

Stabilizer bar may be disconnected or removed, otherwise original.

[Torque arm at front and rear axle will be allowed on leaf sprung car from 2024.](#)

3.5.4 Steering

3.5.4.1 Steering

The steering stop screws are optional. Only conventional, mechanical power steering is allowed. No additional steering cylinders are allowed unless it's original.

Modifications on the frame during change of steering unit are not allowed except new mounting holes and reinforcement of mounting holes. Cutting away parts of the frame is not allowed.

3.5.5 Brake

3.5.5.1 Brake

Vehicles with drum brakes may be reequipped at both front and rear axles with disc brakes. Brake tubes must be well attached. Brake tubing to brake hose transition points must be secured with rigid metal fasteners, of the type clip or nut. Plastic stripes are not allowed.

3.5.5.2 Parking brake/emergency brake

The parking brake must be maintained in the original position, and in good condition. It's allowed to relocate / modify the parking brake handle if it's not reachable with 4/6 point harness.

If the parking brake is mounted on the transferbox, no changes are allowed.

If the parking brake is mounted at the drums of the rear axle, it's only allowed to re-manufacture the brake system on the rear axle, and mountingpoints of the brake-cables at the body.

It is allowed to move a foot operated parking brake-pedal sideways to allow mounting of a 6-point rollcage. The parking/emergency brake must be able to slow down the vehicle in case of failure of the regular brakes. See 3.2.5 for test procedure.

3.5.5.3 Steering brake

Not allowed.

3.5.6 Wheels

3.5.6.1 Tire

The maximum size of tires is 900 x 320 mm.

Max depth of the tire pattern is 20 mm, measure point is in the middle of the profile.

With remolded tires the tread depth may be maximally 20 mm, measure point is in the middle of the profile. The maximum of allowed tire types are Mud-terrain-profiles (MT-The use of competition tires like nops, "alligator", "Super-cross", chains, spikes or tires of other means are not allowed. The mounting of dual tires is not permitted. If there are doubts about the profile, the Eurotrial-committee must decide. The recutting of the tires-profile is not allowed (so far refused tires see ANNEX 3.3).

3.5.6.2 Rim

Free of choice. Maximum 18" (diameter, wideness and insertion depth).

Track widening/wheel spacers are allowed.

All kinds of bead lock system (internal and external) is allowed.

3.5.6.3 Wings

The tire track (profile area) must not go beyond the wings in vertical line. If this is not the case, this can be achieved in form of flared wings. The material of the flared wings must consist of solid and not transparent material.

3.5.7 Engine

3.5.7.1 Engine

Optional.

The engine may only be replaced with an engine with the same or fewer number of cylinders than original (manufacturer is not restricted). Additional tuning is free of will, but no supplementary additions (Compressor, turbo, NOX-injection, etc)...

3.5.7.2 Mixture preparation

If there is a defect with the gas control it must be ensured that the engine goes on idling (e.g.: by a spring at throttle valve shaft).

3.5.7.3 Cooling

Free of choice, but the radiator must maintain in its original place in the engine bay.

3.5.7.4 Fuetank / fuepipe

The fuel tank is free of choice. It must be firmly joined in a sufficiently protected position and installed to the vehicle. It must not be in the passenger compartment. The fuel tank must be separated from the passenger compartment by a fireproof guard. The fuel tank has to be leak proof in any position of the car or the fuel tank.

If non serial tank is used there must be an anti-return breather valve fitted.

3.5.7.5 Exhaust

The Exhaust opening from the side or from above must be behind the middle of the wheelbase. Exhaust pipes may not exceed laterally over the body. The rear of the exhaust system must be designed so that it's possible to make a control of vehicle noise without problem. Noise limitation: The volume of the exhaust system may reach max. 98+2 decibel (DMSB near field measuring method)

3.5.8 Drivetrain

3.5.8.1 Gearbox

Gearbox, transference and gearbox ratios are optional. The drive system (permanent or disengageable) may not be changed. Vehicles with automatic gearboxes must be secured so that the engine only can be started in "Neutral" and/or "Park".

3.5.8.2 Axle/axle ratio

Axles must correspond to original. Axle ration is optional.

All kinds of portal-axles are forbidden. Even if it's original equipment.

3.5.8.3 Diff-lock

Optional for both rear and front axle.

3.5.8.4 Disconnect of axle / drive system

The disengagement of drive axles is not permitted, unless it corresponds to the series.

Remanufacturing to 2WD Low is not permitted.

3.5.9 Electric

3.5.9.1 Battery

The battery must be securely fastened in its original place.

The positive battery terminal has to be covered to prevent contact to other metal parts.

3.5.9.2 Main circuit breaker

A main circuit breaker is mandatory. The main circuit breaker must cut all electrical circuits, battery, alternator or dynamo, lights, ignition, electrical controls, etc. and must also stop the engine.

It is allowed to not break "memory" power supply to the engine control unit, gearbox control unit and similar electronic units in the car. The memory power supply line must be protected by a fuse

mounted near the positive pole of the battery.

The main circuit breaker must be installed on the driver's side in front of the windshield. It must be reachable from the inside and from the outside. It must have a noticeably marked on/off position. Diesel engines which do not have an electrical "turn off"-solenoid must have a "stop the engine"-wire installed along with the main circuit breaker.

3.5.9.3 Lights

It is mandatory to keep the appearance of original headlights in the front of the vehicle. Either by using original lights or they can be painted, printed or made as a sticker. Otherwise optional.

3.5.9.4 Electronic support

It is not allowed to use electronic support like radios, cameras and sensors.

3.6 TRIAL GROUP M “MODIFIED” (IMPROVED SERIES VEHICLES)

3.6.1 General information

Vehicle modifications are only allowed as specified in the rules.

The car must follow the manufacturer's conditions, like EU regulations or main importer regulations. All accessories and all special equipment which can be supplied with the vehicle purchase is allowed unless specifically restricted.

Only ordinary diesel or petrol fuel is allowed.

Beyond this the following regulations apply:

3.6.2 Frame/body

3.6.2.1 Frame/chassis/wheelbase

Main frame rails must be maintained in original in design, length and construction.

Front and rear crossmember are not allowed to remove or modify between main frame rails.

Other crossmember can be modified. The structural strength of the frame may not be weakened.

Fittings/brackets for engine, gearbox, transfer box, axles, torsion sticks, radius arms, springs, shock absorbers, exhaust system and other bracketry may be (re-)moved or modified. Bumper mounting points can be removed or modified.

Body mounts must be kept in original position, and quantity on frame and body. They must not be changed so that they weaken, but may be strengthened freely.

The length and width of the chassis/frame must be kept as original.

If the car was originally built with a self-supporting body (unibody/monocoque), the “frame” or sub-frame parts must be kept in original dimensions and positions.

The wheelbase and the position of the axles longitudinally may vary up to 1% of the original specifications.

3.6.2.2 Body

The body above the belt line can be modified.

Belt line is defined as: In front, the line of the bonnet. For open vehicles back and side, the side above the wall. For closed vehicles, (if no open version exists) the bottom edge of the side window, and the back window.

Exception: Under the belt line the wheel arch can be cut in the same profile of the body, max. 100 mm to accept bigger wheels. For flat-fender vehicles (like Jeep Willys, Jeep Wrangler, Suzuki LJ etc.) the front fenders can be raised and/or cut by max. 100mm in all.

The lower front corner of the front wings may be reduced max 100mm in height, or maximum up to the grill / light frame and max to the chassis from the side.

The lower rear corner behind the rear wheels may be reduced max 100mm, or up to the floor and max to the chassis from the side.

The doorsill cover may be reduced by 100mm but a maximum up to the doorsill beam.

Parts that are attached/fitted by screws to the body (e.g. bonnet, wings etc.) may be replaced by parts made of metal, plastic or fiberglass, provided they have identical external dimensions. Inner front wings can be removed. For vehicles with self-supporting body a new supporting structure has to be welded in place. Internal brackets etc. can be removed.

Body protection is allowed.

3.6.2.3 Dimension / Vehicle outline

The dimensions must correspond to the manufacturer data.

The vehicle outline may not be changed with masking tape or similar temporary measures.

3.6.2.4 Window/window frame/mirror

The windscreen and the windscreen frame including its fastening parts may be removed.

In case a windscreen is used it must consist of laminated glass, "Lexan" or "Makrolon". Plexiglas is forbidden. Windscreens should not have damages, for safety reasons. Should damage occur the windscreen must be approved by technical control.

Mirrors of all kinds are allowed.

3.6.2.5 Body lift

Body lift is permitted. This must be rigid.

3.6.2.6 Bumpers

Bumpers may be removed or changed to other non-serial bumpers, however the form is not allowed to be moulded or shaped to the vehicle. The material must be rigid and firm. Material thickness is optional: Cover plates (or similar material) between body and frame is forbidden.

3.6.2.7 Floor / firewall / transmission tunnel

Floor and firewall must be present and in original place and material.

Floor in passenger area in front of the B bar, can only be modified

~~Holes and/or minor modifications~~ to accommodate for hoses, pipes, cables, exhaust. ~~etc are allowed.~~

Modifying the transmission tunnel is allowed. Widening the tunnel is limited to 50mm to each side.

Floor behind B bar might have hole for shock absorber.

3.6.2.8 Passenger area

A protective wall must be present to protect driver and co-driver from engine, oil cooler, radiator and to prevent fire or fluid from spreading into the passenger area.

3.6.2.9 Seats

The seats for the driver/co-driver must be well secured. Seats must have head restraints that covers at least 2/3 height of the helmet. Co-driver's seat must be present. Its allowed to replace the original seats with racing seats with the possibility for 4-point harness.

3.6.2.10 Harness

Harness must at least be of type 4-point belts or so-called suspender belts (y-belts) or more, and they must be well attached to the body and/or roll cage according to harness manufacturer's specifications. The harness must be in good condition and may not be modified. If new mounting points are created in the body, a steel reinforcement plate with a surface area of at least 40 cm² and a thickness of at least 3 mm must be used. The passengers must be buckled at all time in the section during driving or rescue. The belt system used is to be put on according to its regulation and may not be manipulated. Vehicles with active airbag or belt restrain systems must be marked at both doors with the "Airbag"-symbol. It's allowed to remove the airbags.

3.6.2.11 Roll cage

A six-point roll cage is mandatory. The roll cage must consist of a basic structure according to 3.2.6.4, backstays, diagonal member 3.2.6.6 and roof reinforcement 3.2.6.7.

External roll cage is allowed.

See 3.2.6 for more info.

3.6.2.12 Protective netting /Arm straps

Protection nets or arm straps must be used. Net must cover the door/window area so the arm/hand cannot come outside the car. This also applies to arm straps. If arm straps are used they must open together with the harness.

3.6.2.13 Body attachment

Hardtop, tarpaulin with linkages inclusive all locked mounting plates, tailgate, rear seats, spare wheel, spare wheel handle, mirror and mirror handle, side and back windows, side turn signals, door handles and door upper sections may be removed. (door lower part must be present). Interior door panel must be present. Material free, however not paper, cardboard, fabric or similar. Original doors can be changed to half-doors. The door must be able to open from the outside, or have a marking on the outside that shows where the opening is on the inside of the door. Definition for half doors: There must be a cover available, which prevents feet or legs from falling out when the vehicle is tilted. This cover must have at least the height of the belt line of the vehicle. In addition, EUROTRIAL RULES 2019 PART III – TECHNICAL RULES – DRAFT the cover must have at least the height of the highest point of the unloaded seat. The cover can consist of e.g. sheet metal, wood, lattice, etc. and the material must not be transparent. The cover/half door can be made to be opened.

3.6.2.14 Fluid tubes

A protection of the fluid tubes for the fuel -, oil-, and brake hoses outside of the body must be provided against damages (stones, corrosion, mechanical breaks etc..)

Inside the body the tubes must be protected from any fire risk and/or potential damage by rigid metal shield. Fuel/coolant-tube/pipe/hose going through the drivers cabin must be “seamless” (no connections/joints inside drivers cabin) to prevent fluid from spreading into the passenger area.

If the series arrangement is maintained, no additional protection is necessary.

3.6.2.15 Towing eye/hook

There must be at least one towing eye or hook in the front and one in the back with an inside diameter of at least 50 mm. They must be well proportioned, firmly embodied, easily accessible and painted red, yellow or orange in contrast to the vehicle.

3.6.2.16 Under shield

Under shield is optional.

3.6.3 Suspension

3.6.3.1 Spring / Radius Arms / Axle mounting arms

Spring type change is allowed from original spring type to leaf spring, coil spring or coil overs only. No other spring types are allowed unless they are original springs. Air shocks are not permitted.

The mounting points on frame / body and axles are free.

“Spring over axles” is allowed.

Shackle reverse is allowed, meaning: cars with shackles in front of the leaf spring can change to shackle in the back of the leaf spring and otherwise.

Number, length and position of the axle mounting arms and radius arms are free in case of solid axles. In case of original IFS/IRS the mounting points on the frame/chassis and on the stub axle have to be kept in original position.

3.6.3.2 Spring pendants

Longer spring pendants are permitted.

3.6.3.3 Shock absorber

Shock absorbers are optional, however the number of shock absorbers and the working principle must be kept as original.

Gas-pressure shock absorbers are to be regarded by work principle as hydraulic shock absorbers.

It is forbidden to be able to adjust the shocks while driving.

3.6.3.4 Bump stop

Optional.

Hydraulic bump stops are not permitted.

3.6.3.5 Level control

A serial level control is allowed if originally fitted to the vehicle, and the vehicle have original spring system. may be inserted while maintaining the original work version.

3.6.3.6 Torsion stick / Stabilizer bar

Optional. See 3.6.3.1

3.6.4 Steering

3.6.4.1 Steering

The steering stop screws are optional. Only conventional, mechanical power steering is allowed. Modifications on the frame during change of steering unit are not allowed except new mounting holes and reinforcement of mounting holes. Cutting away parts of the frame is not allowed.

3.6.5 Brakes

3.6.5.1 Brake

The brake assembly is optional. The braking force distribution at an axle must be equal. The serial braking force distribution between both axles must not be changed.

Brake tubes must be well attached. Brake tubing to brake hose transition points must be secured with rigid metal fasteners, of the type clip or nut. Plastic stripes are not allowed.

3.6.5.2 Parking brake/emergency brake

A well functional parking brake/emergency brake must be present, engaging the brakes of the rear axle, or the driveshaft of the rear-axle. The control system of the parking brake can be operated hydraulically or mechanically and it must be mechanically independent of the main system.

The control system must be possible to engage with one hand or foot and it must automatically remain locked when engaged. The parking/emergency brake must be able to slow down the vehicle in case of failure of regular brakes. See 3.2.5 for test procedure.

3.6.5.3 Steering brake

Not allowed.

3.6.6 Wheels

3.6.6.1 Tire

Agricultural tractor profiles, spikes, chains and dual tires are not permitted, otherwise tires is optional. Tire diameter is limited to 1000mm.

3.6.6.2 Wheel/Rim

Optional. Maximum diameter 18". Track widening/wheel spacers are allowed.

3.6.6.3 Wings

1/3 of the tire track (profile area) must be covered with a wing. If this is not the case, this can be achieved in form of flared wings. The wing must cover the tire from the sill and 120 degrees of the tires radius.

The material of the flared wings must consist of solid and non-transparent material.

3.6.7 Engine

3.6.7.1 Engine

Optional. NOX-injection are not allowed.

3.6.7.2 Mixture preparation

If there is a defect with the throttle control it must be ensured that the engine returns to idle (e.g.: by a spring at throttle valve shaft).

3.6.7.3 Cooling

Optional. Radiator must not be placed in the passenger area. If the radiator is placed behind the passenger area, it must be covered with protective walls to prevent hot water from reaching driver/co-driver at any angle. Even if the car has rolled over. The radiator, hoses and pipes should be securely fastened, and if water pipes and hoses go through the passenger area, they must be well protected to prevent the driver and co-driver from scalding or burning.

3.6.7.4 Fuel tank / fuel pipe

The fuel tank is optional. Fuel tank of racing type is recommended. It must be firmly joined in a sufficiently protected position and installed to the vehicle. It must not be in the passenger compartment. The fuel tank must be separated from the passenger compartment by a fireproof guard. The fuel tank must be leak proof in any position of the car or the fuel tank.

Tank fasteners must be made by metal only.

If non serial tank is used there must be an anti-return breather valve fitted.

3.6.7.5 Exhaust

The Exhaust opening from the side or from above must be behind the middle of the wheelbase.

Exhaust pipes may not exceed laterally over the body. The rear of the exhaust system must be designed so that it's possible to make a control of vehicle noise without problem.

Noise limitation:

The volume of the exhaust system may reach max. 98+2 decibel (DMSB near field measuring method)

3.6.8 Drivetrain**3.6.8.1 Gearbox**

Gearbox, transfer case and gearbox ratios are optional. The use of differential lock in transfer case are optional. The car models original drive system (permanent or disengageable) may not be changed.

Vehicles with automatic gearboxes must be secured so that the engine only can be started in "Neutral" or "Park".

3.6.8.2 Axle/axle ratio

The axles can be changed.

Vehicles with straight axles:

Axles can be changed for straight axles only. Conversion to IFS/IRS suspension is forbidden.

Vehicles with independent suspension (front or front/rear):

The mounting Points on the frame / chassis and on the stub axle have to been kept in original position and place.

Vehicles that are rebuilt from independent suspension to straight axles:

Independent suspension can be changed to solid axles.

Axle ratio is optional.

Portal axles are forbidden.

All vehicles with borderline axles (like Ford Bronco / TTB axles) are considered as IFS.

3.6.8.3 Diff-lock

Optional for both rear and front axle.

3.6.8.4 Disconnect of axle / drive system

The disengagement of the power transmission of individual wheels or drive axles is not permitted, unless it corresponds to the cars original series. Remanufacturing to 2WD Low is not permitted.

3.6.9 Electric

3.6.9.1 Battery

Optional. Electrical cables must be well protected.

The positive battery terminal must be covered to prevent contact to other metal parts.

Battery must be firmly secured to body/chassis by metal fasteners only.

3.6.9.2 Main circuit breaker

A main circuit breaker is mandatory. The main circuit breaker must cut all electrical circuits, battery, alternator or dynamo, lights, ignition, electrical controls, etc. and must also stop the engine.

It is allowed to not break "memory" power supply to the engine control unit, gearbox control unit and similar electronic units in the car. The memory power supply line must be protected by a fuse mounted near the positive pole of the battery.

The main circuit breaker must be installed on the driver's side in front of the windshield. It must be reachable from the inside and from the outside. It must have a noticeably marked on/off position. Diesel engines which do not have an electrical "turn of"-solenoid must have a "stop the engine"-wire installed along with the main circuit breaker.

3.6.9.3 Lights

It is mandatory to keep the appearance of original headlights in the front of the vehicle. Either by using original lights or they can be painted, printed or made as a sticker. Otherwise optional.

3.6.9.4 Electronic support

It is not allowed to use electronic support like radios, cameras and sensors.

3.7 TRIAL GROUP PM “PROMODIFIED”

3.7.1 General information

Vehicles should have 2 axles and 4wd. The construction of the chassis is free. Use of equipment that are not written in this rules and that will make the vehicle more competitive is forbidden. Only diesel or ordinary petrol is allowed as fuel. Beyond this the following regulations apply:

3.7.2 Frame/body

3.7.2.1 Frame/chassie/wheelbase

Optional.

3.7.2.2 Body

The body work must consist of a bonnet (hood), front wings, body sides and rear wings, and the body panels must cover the vehicle within the yellow square. Body panels material is optional, but may not be transparent or see trough. The front of the car must retain a mask or face with appearance of lights. For dimensions se point 3.7.2.3.

3.7.2.3 Dimension / Vehicle outline

The minimum body has to be minimum from middle of front axle to the middle of rear axle, and from the inside wheels of right side to inside wheels of left side, and must consist of a solid construction in minimum the size as in the picture beside. It's not allowed to make attachment to the body just to make it wider or longer. Single seaters is not allowed, two fullsize seats side by side should be fit inside the body. The body has to be minimum the allowed size from the bottom of the body to at least the beltline.

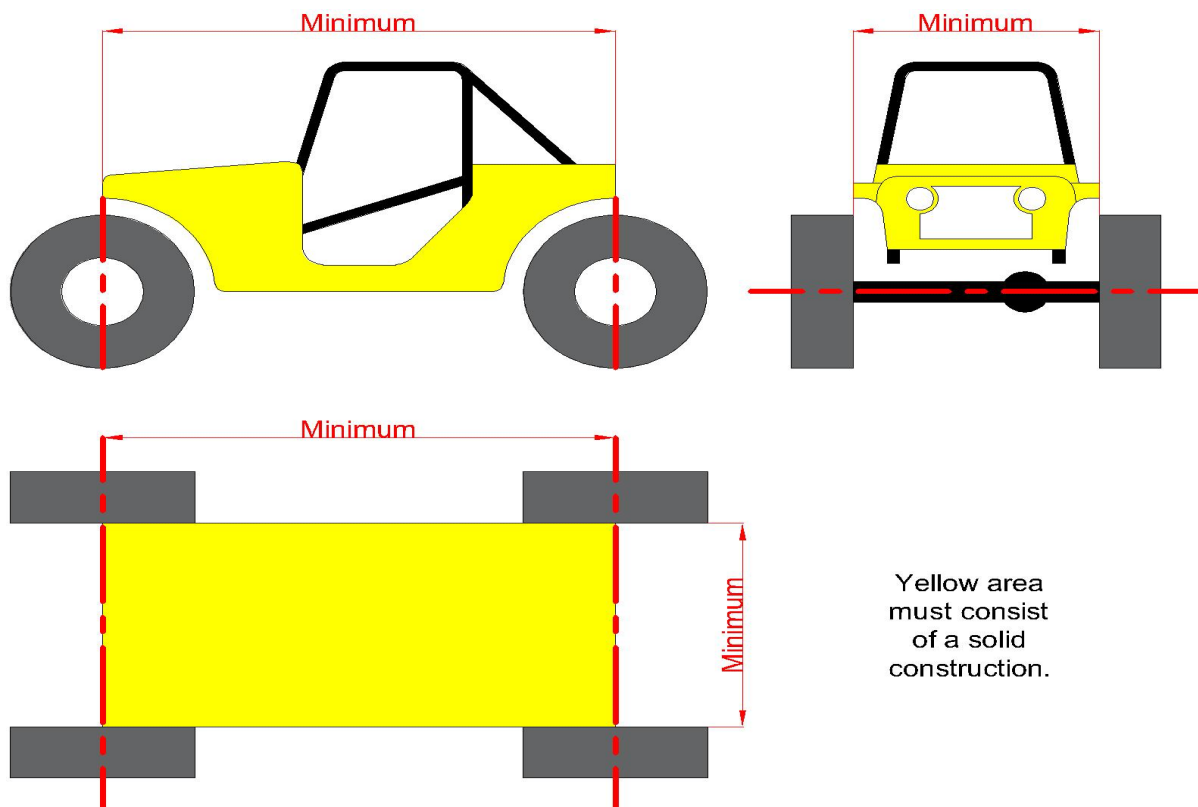

3.7.2.4 Window/window frame/mirror

The windscreen and the windscreen frame including its fastening parts may be removed. In case a windscreen is used it must consist of laminated glass, Lexan/Polycarbonat or Makrolon. Plexiglas is forbidden. Windscreens should not have damages, for safety reasons. Should damage occur the windscreen must be approved by technical control.

Mirrors of all kinds are allowed.

3.7.2.5 Body lift

Bodylift is permitted. This must be rigid.

3.7.2.6 Bumper

Optional.

3.7.2.7 Floor / firewall / transmission tunnel

A floor plate made out of minimum 2mm thick Aluminum or 1 mm thick steel has to be installed in case the original floor plate is not existing. Changes of the firewall and the transmission tunnel are allowed. Floor must be solid from front firewall to the rear firewall behind seats / inside drivers cabin to prevent fire or fluid from spreading into the passenger area.

3.7.2.8 Passenger area

A protective wall must be present to protect driver and co-driver from engine, oil cooler, radiator and to prevent fire or fluid from spreading into the passenger area.

3.7.2.9 Seats

Seat of racing type with the possibility for 4 point harness must be present. The seats for the driver/codriver must be well secured, and if the seat is adjustable it should have a locking device at both sides. Seats must have head restraints that covers at least 2/3 height of the helmet. Codrivers seat must be present.

3.7.2.10 Harness

Harness must at least be of type 4-point belts or so-called suspender belts (y-belts) or more, and they must be well attached to the body and/or rollcage according to harness manufacturer's specifications. The harness must be in good condition and may not be modified. If new mounting points are created in the body, a steel reinforcement plate with a surface area of at least 40 cm² and a thickness of at least 3 mm must be used. The passengers must be buckled at all time in the section during driving or rescue. The belt system used is to be put on according to its regulation and may not be manipulated. Vehicles with active airbag or belt restrain systems must be marked at both doors with the "Airbag"-symbol. It's allowed to remove the airbags.

3.7.2.11 Rollcage

A sixpoint rollcage is mandatory. The rollcage must consist of a Basic structure according to 3.2.6.4, doorbar 3.2.6.5, backstays, diagonal member 3.2.6.6 and roof reinforcement 3.2.6.7. There must be a space of at least five cm from inside the tubes in the rollcage to the drivers/codrivers shoulder arm in a normal position. If not, the car must be fitted with side nets to prevent injury to the driver/co-driver.

External rollcage is allowed.

See 3.2.6 for more info.

3.7.2.12 Protective netting / Armstraps

Protection nets or armstraps must be used. Net must cover the door/window area so the arm/hand cannot come outside the car. This also applies to armstraps. If arm straps are used they must open together with the harness.

3.7.2.13 Body attachment

Hardtop, tarpaulin with linkages inclusive all locked mounting plates, tailgate, rear seats, spare wheel, spare wheel handle, mirror and mirror handle, side and back windows, side turn signals, door handles and doors may be removed. If doors are present, interior door panel must be present. Material free, however not paper, cardboard, fabric or similar. Doors/netdoors must be able to open from the outside, or have a marking on the outside that shows where the opening is on the inside of the door.

3.7.2.14 Fluid tubes

A protection of the fluid tubes for the fuel -, oil-, and brake hoses outside of the body must be provided against damages (stones, corrosion, mechanical breaks etc..)

Inside the body the tubes must be protected from any fire risk and/or potential damage by rigid metal shield. Fuel/coolant-tube/pipe/hose going through the drivers cabin must be "seamless" (no connections/joints inside drivers cabin) to prevent fluid from spreading into the passenger area. If the series arrangement is maintained, no additional protection is necessary.

3.7.2.15 Towing eye/hook

There must be either one towing eye or hook in the front and in the back with an inside diameter of at least 50 mm. They must be firmly embodied, easily accessible and have to be painted red, yellow or orange, so that the body of the vehicle contrast with the towing eye/hook.

3.7.2.16 Undershield

Undershield is optional.

3.7.3 Suspension

3.7.3.1 Spring

Active suspensions, hydraulic or air are forbidden, otherwise optional.

3.7.3.2 Spring pendants

Longer spring pendants are permitted.

3.7.3.3 Shock absorber

Optional. Air shocks allowed.

Shock absorbers with external reservoir and/or filling valves for gas or oil, must have a rigid protection of connections at shock absorber, valves, hoses and external reservoirs to prevent oil or gas spurting on to driver, codriver or officials in case of damage by a rollover. Cover by roll cage or body is sufficient. Protection sock/sleeve for the hydraulic line(s) is recommended.

3.7.3.4 Bump stop

Optional.

3.7.3.5 Level control

Not allowed.

3.7.3.6 Torsion stick / Stabilizer bar

Optional.

3.7.4 Steering**3.7.4.1 Steering**

Rear-wheel steering or frame-steering is not allowed, otherwise free. Only the driver are allowed to steer the vehicle in a section.

3.7.5 Brake**3.7.5.1 Brake**

The brake assembly is optional, but there must be at least one brake at each wheel.

The braking force distribution for parking brakes or operating brakes at axles must be equal.

The serial braking force distribution between both axles must not be changed.

Brake tubes must be well attached. Brake tubing to brake hose transition points must be secured with rigid metal fasteners, of the type clip or nut. Plastic stripes are not allowed.

Single wheel brakes are allowed.

3.7.5.2 Parking brake/emergency brake

A well functional parking brake must be present, operating on the brakes of one and the same axle, or the driveshaft of one axle. The control system of the parking brake can be operated electric, hydraulically or mechanically, and it must be mechanically independent of the main system.

The control system of the parking brake must be possible to engage with one hand or one foot, and it must automatically remain locked when engaged.

The vehicle must also be fitted with an emergency brakesystem. The emergency brake system can be shared with the parking brake, or be a total separate system, and it must be able to slow down the vehicle in case of failure of regular brakes. If the vehicle is equipped with a inline cutting-brakesystem of the "American" type, where each wheel is able to brake individually without using the foot brake pedal and it's associated brake master cylinder, the brake system is approved as emergency brake system despite that brake lines, hoses and calipers are shared with the main brake system. See 3.2.5 for test procedure.

3.7.5.3 Steering brake

Optional. Only the driver is allowed to operate the steering brakes.

3.7.6 Wheels**3.7.6.1 Tire**

Rubber tires filled with air, otherwise optional. The maximum height of tires is 1000mm. Spikes, chains and dual tires are not permitted.

3.7.6.2 Rim

Optional. Track widening/wheel spacers are allowed.

All kinds of bead lock system (internal and external) is allowed.

3.7.6.3 Wings

1/3 of the tire track (profile area) must be covered with a wing. If this is not the case, this can be achieved in form of flared wings. The wing must cover the tire from the sill and 90 degrees of the

tires radius.

The material of the flared wings must be made out of solid and not transparent material.

3.7.7 Engine

3.7.7.1 Engine

Optional.

NOX-injections are not allowed.

3.7.7.2 Mixture preparation

If there is a defect with the gas control it must be ensured that the engine goes on idling (e.g.: by a spring at throttle valve shaft).

3.7.7.3 Cooling

Optional. Radiator must not be placed in the passenger area. If the radiator is placed behind the passenger area, it must be covered with protective walls to prevent hot water from reaching driver/codriver at any angle. Even if the car has rolled over. The radiator, waterhoses and waterpipes should be securely fastened, and if water pipes and hoses go through the passenger area, they must be well protected to prevent the driver and codriver from scalding or burning. All tubes under the vehicle containing hot fluid (above 50° C) must be well protected, or painted bright red to warn the marshalls from scalding or burning in case of a roll-over.

3.7.7.4 Fuel tank / fuelpipe

The fuel tank is optional. Fuel tank of racing type is recommended. It must be firmly joined in a sufficiently protected position and installed to the vehicle. It must not be in the passenger compartment. The fuel tank must be separated from the passenger compartment by a fireproof guard. The fuel tank has to be leak proof in any position of the car or the fuel tank.

If non serial tank is used there must be an anti-return breather valve fitted.

3.7.7.5 Exhaust

Optional, but the exhaust opening from the side or from above must be behind the middle of the wheelbase, and all pipes that may be touched from outside the vehicle must be covered with thermal protection. Exhaust pipes may not exceed laterally over the body. The rear of the exhaust system must be designed so that it's possible to make a control of vehicle noise without problem. Noise limitation: The volume of the exhaust system may reach max. 98+2 decibel (DMSB near field measuring method)

3.7.8 Drivetrain

3.7.8.1 Gearbox

Optional, but no "Hydrostat engines".

Vehicles with automatic gearboxes must be secured so that the engine only can be started in "Neutral" and/or "Park".

3.7.8.2 Axle/axle ratio

Optional.

3.7.8.3 Diff-lock

Optional.

3.7.8.4 Disconnect of axle / drive system

Optional.

3.7.9 Electric**3.7.9.1 Battery**

Optional. Electrical cables should be well protected.

The positive battery terminal has to be covered to prevent contact to other metal parts.

3.7.9.2 Main circuit breaker

A main circuit breaker is mandatory. The main circuit breaker must cut all electrical circuits, battery, alternator or dynamo, lights, ignition, electrical controls, etc. and must also stop the engine.

It is allowed to not break "memory" power supply to the engine control unit, gearbox control unit and similar electronic units in the car. The memory power supply line must be protected by a fuse mounted near the positive pole of the battery.

The main circuit breaker must be installed on the driver's side in front of the windshield. It must be reachable from the inside and from the outside. It must have a noticeably marked on/off position. Diesel engines which do not have an electrical "turn of"-solenoid must have a "stop the engine"-wire installed along with the main circuit breaker.

3.7.9.3 Lights

It is mandatory to keep the appearance of original headlights in the front of the vehicle. Either by using original lights or they can be painted, printed or made as a sticker. Otherwise optional.

3.7.9.4 Electronic support

It is not allowed to use electronic support like radios, cameras and sensors.

3.8 TRIAL GROUP P “PROTOTYPE”

3.8.1 General information

Only vehicles with four-wheel drive, two axles and four air pressured tires are entitled to take part. A vehicle, whose construction seems to have certain dangers, can be excluded from the participation. Only diesel, ordinary petrol or leak proof batteries is allowed as fuel. Beyond this the following regulations apply:

3.8.2 Frame/body

3.8.2.1 Frame/chassie/wheelbase

Optional.

3.8.2.2 Body

The body must be of impeccable construction and must not present provisory elements. It may not have sharp edges and must offer a sufficient protection to the passengers. All rotary parts of the motor and propulsion shaft must be sufficiently protected. A protective wall must be present to protect driver and co-driver from engine, oil cooler, radiator and to prevent fire or fluid from spreading into the passenger area.

3.8.2.3 Dimension / Vehicle outline

Optional.

3.8.2.4 Window/window frame/mirror

The windscreen and the windscreen frame including its fastening parts may be removed. In case a windscreen is used it must consist of laminated glass, Lexan/Polycarbonat or Makralon. Plexiglas is forbidden. Windscreens should not have damages, for safety reasons. Should damage occur the windscreen must be approved by technical control. Mirrors of all kinds are allowed.

3.8.2.5 Body lift

Bodylift is permitted. This must be rigid.

3.8.2.6 Bumper

Optional.

3.8.2.7 Floor / firewall / transmissiontunnel

A floor plate made out of minimum 2mm thick Aluminum or 1 mm thick steel has to be installed in case the original floor plate is not existing. Changes of the firewall and the transmission tunnel are allowed. Floor must be solid from front firewall to the rear firewall behind seats / inside drivers cabin to prevent fire or fluid from spreading into the passenger area.

3.8.2.8 Passenger area

A protective wall must be present to protect driver and co-driver from engine, oil cooler, radiator and to prevent fire or fluid from spreading into the passenger area.

3.8.2.9 Seats

The number of seats is optional. Seat of racing type with the possibility for 4-point harness must be present. The seats for the driver/codriver must be well secured, and if the seat is adjustable it should

have a locking device at both sides. Seats must have head restraints that covers at least 2/3 height of the helmet.

3.8.2.10 Harness

Harness must at least be of type 4-point belts or so-called suspender belts (y-belts) or more, and they must be well attached to the body and/or rollcage according to harness manufacturer's specifications. The harness must be in good condition and may not be modified. If new mounting points are created in the body, a steel reinforcement plate with a surface area of at least 40 cm² and a thickness of at least 3 mm must be used. The passengers must be buckled at all time in the section during driving or rescue. The belt system used is to be put on according to its regulation and may not be manipulated. Vehicles with active airbag or belt restrain systems must be marked at both doors with the "Airbag"-symbol. It's allowed to remove the airbags.

3.8.2.11 Rollcage

A sixpoint rollcage is mandatory. The rollcage must consist of a Basic structure according to 3.2.6.4, doorbar 3.2.6.5, backstays, diagonal member 3.2.6.6 and roof reinforcement 3.2.6.7. There must be a space of at least five cm from inside the tubes in the rollcage to the drivers/codriver's shoulder arm in a normal position. If not, the car must be fitted with side nets to prevent injury to the driver/co-driver. External rollcage is allowed. See 3.2.6 for more info.

3.8.2.12 Protective netting / Arm straps

Protection nets or armstraps must be used. Net must cover the door/window area so the arm/hand cannot come outside the car. This also applies to armstraps. If arm straps are used they must open together with the harness.

3.8.2.13 Body attachment

Hardtop, tarpaulin with linkages inclusive all locked mounting plates, tailgate, rear seats, spare wheel, spare wheel handle, mirror and mirror handle, side and back windows, side turn signals, door handles and doors may be removed. If doors are present, interior door panel must be present. Material free, however not paper, cardboard, fabric or similar. Doors/netdoors must be able to open from the outside, or have a marking on the outside that shows where the opening is on the inside of the door.

3.8.2.14 Fluid tubes

A protection of the fluid tubes for the fuel -, oil-, and brake hoses outside of the body must be provided against damages (stones, corrosion, mechanical breaks etc..)

Inside the body the tubes must be protected from any fire risk and/or potential damage by rigid metal shield. Fuel/coolant-tube/pipe/hose going through the drivers cabin must be "seamless" (no connections/joints inside drivers cabin) to prevent fluid from spreading into the passenger area.

If the series arrangement is maintained, no additional protection is necessary.

3.8.2.15 Towing eye/hook

There must be either one towing eye or hook in the front and in the back with an inside diameter of at least 50 mm. They must be firmly embodied, easily accessible and have to be painted red, yellow or orange, so that the body of the vehicle contrast with the towing eye/hook.

3.8.2.16 Undershield

Undershield is optional.

3.8.3 Suspension

3.8.3.1 Spring

Optional. The vehicles must be fitted with spring axles. A rigid connection with the chassis is forbidden.

3.8.3.2 Spring pendants

Longer spring pendants are permitted.

3.8.3.3 Shock absorber

Optional.

Shock absorbers with external reservoir and/or filling valves for gas or oil, must have a rigid protection of connections at shock absorber, valves, hoses and external reservoirs to prevent oil or gas spurting on to driver, codriver or officials in case of damage by a rollover. Cover by roll cage or body is sufficient. Protection sock/sleeve for the hydraulic line(s) is recommended.

3.8.3.4 Bump stop

Optional.

3.8.3.5 Level control

Optional.

3.8.3.6 Torsion stick / Stabilizer bar

Optional.

3.8.4 Steering

3.8.4.1 Steering

Frame-steering is not allowed, otherwise free. Only the driver is allowed to steer the vehicle in a section.

3.8.5 Brake

3.8.5.1 Brake

The brake assembly is optional, but there must be at least one brake at each wheel.

The braking force distribution for parking brakes or operating brakes at axles must be equal.

Brake tubes must be well attached. Brake tubing to brake hose transition points must be secured with rigid metal fasteners, of the type clip or nut. Plastic stripes are not allowed.

Single wheel brakes are allowed.

3.8.5.2 Parking brake/emergency brake

A well functional parking brake must be present, operating on the brakes of one and the same axle, or the driveshaft to one axle. The control system of the parking brake can be operated electric, hydraulically or mechanically, and it must be mechanically independent of the main system.

The control system of the parking brake must be possible to engage with one hand or one foot, and it must automatically remain locked when engaged.

The vehicle must also be fitted with an emergency brake system. The emergency brake system can be shared with the parking brake, or be a total separate system, and it must be able to slow down the vehicle in case of failure of regular brakes. If the vehicle is equipped with a inline cutting-brake

system of the "American" type, where each wheel is able to brake individually without using the foot brake pedal and it's associated brake master cylinder, the brake system is approved as emergency brake system despite that brake lines, hoses and calipers are shared with the main brake system. See 3.2.5 for test procedure.

3.8.5.3 Steering brake

Optional. Only the driver is allowed to operate the steering brakes.

3.8.6 Wheels

3.8.6.1 Tire

Rubber tires filled with air, otherwise optional. The maximum height of tires is 1250mm. Spikes, chains and dual tires are not permitted.

3.8.6.2 Rim

Optional. Track widening/wheel spacers are allowed.

All kinds of bead lock system (internal and external) is allowed.

3.8.6.3 Wings

-

3.8.7 Engine

3.8.7.1 Engine

Optional. Only one engine is allowed.

NOX-injection is not allowed.

3.8.7.2 Mixture preparation

If there is a defect with the gas control it must be ensured that the engine goes on idling (e.g.: by a spring at throttle valve shaft).

3.8.7.3 Cooling

Optional.

Radiator must not be placed in the passenger area. If the radiator is placed behind the passenger area, it must be covered with protective walls to prevent hot water from reaching driver/codriver at any angle. Even if the car has rolled over. The radiator, waterhoses and waterpipes should be securely fastened, and if water pipes and hoses go through the passenger area, they must be well protected to prevent the driver and codriver from scalding or burning. All tubes under the vehicle containing hot fluid (above 50° C) must be well protected, or painted bright red to warn the marshalls from scalding or burning in case of a roll-over.

3.8.7.4 Fuetank / fuelpipe

The fuel tank is optional. Fuel tank of racing type is recommended. It must be firmly joined in a sufficiently protected position and installed to the vehicle. It must not be in the passenger compartment. The fuel tank must be separated from the passenger compartment by a fireproof guard. The fuel tank has to be leak proof in any position of the car or the fuel tank.

If non serial tank is used there must be an anti-return breather valve fitted.

3.8.7.5 Exhaust

Optional. Exhaust pipes that may be touched from outside the vehicle must be covered with thermal protection. Exhaust pipes may not exceed laterally over the body. The rear of the exhaust system must be designed so that it's possible to make a control of vehicle noise without problem. Noise limitation: The volume of the exhaust system may reach max. 98+2 decibel (DMSB near field measuring method)

3.8.8 Drivetrain

3.8.8.1 Gearbox

Optional, but no "Hydrostat engines".

Vehicles with automatic gearboxes must be secured so that the engine only can be started in "Neutral" and/or "Park".

3.8.8.2 Axle/axle ratio

Optional.

3.8.8.3 Diff-lock

Optional.

3.8.8.4 Disconnect of axle / drive system

Optional.

3.8.9 Electric

3.8.9.1 Battery

Optional. Electrical cables should be well protected.

The positive battery terminal has to be covered to prevent contact to other metal parts.

3.8.9.2 Main circuit breaker

A main circuit breaker is mandatory. The main circuit breaker must cut all electrical circuits, battery, alternator or dynamo, lights, ignition, electrical controls, etc. and must also stop the engine.

It is allowed to not break "memory" power supply to the engine control unit, gearbox control unit and similar electronic units in the car. The memory power supply line must be protected by a fuse mounted near the positive pole of the battery.

The main circuit breaker must be installed on the driver's side in front of the windshield. It must be reachable from the inside and from the outside. It must have a noticeably marked on/off position. Diesel engines which do not have an electrical "turn off"-solenoid must have a "stop the engine"-wire installed along with the main circuit breaker.

3.8.9.3 Lights

The choice of tail lights and head lights is optional.

3.8.9.4 Electronic support

It is not allowed to use electronic support like radios, cameras and sensors.